

ramonsoler.

→ Ficha Técnica
Data Sheet
Fiche Technique
Technisches Datenblatt

Alexia

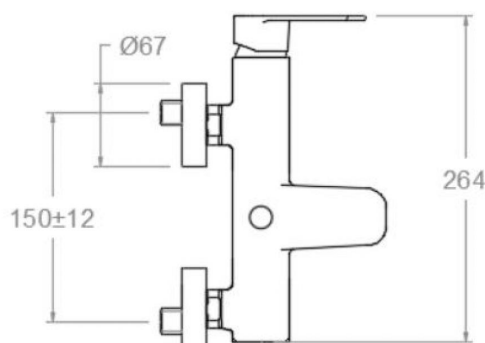
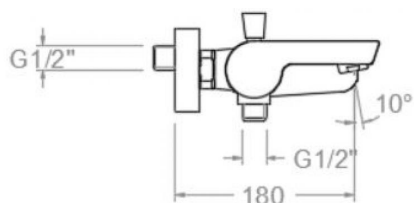

Alexia negro mate, monomando de baño-ducha 360501SNM

Colección: Alexia	Acabado: Negro mate	Código: 36C303662
Ubicación: Baño	Categoría: Bañera	Certificación: N II D/A

Características técnicas

- Certificación AENOR
- Cartucho cerámico Ø35 mm.
- Sistema de ahorro de agua S2 mediante la apertura de la manecilla en dos fases.
- Caudal a 3 bar: 20 l/min en salida de baño y 12 l/min en salida de ducha.
- Resistente al choque térmico y químico antilegionela.
- Garantía de 5 años en grifería y 3 años en complementos.
- Presión de uso entre 1-5 bar. Recomendada 3 bar.
- Resiste presiones estáticas igual o inferior a 10 bar y golpes de ariete de 25 bar.
- Nivel acústico a 3 bar: inferior a 20 dB.
- Prestaciones de confort a nivel de fidelidad, sensibilidad y constancia en la selección de la temperatura.
- Temperatura recomendada de agua caliente 55°C. Temperatura máxima de uso 65°C. Máximo 1h a 90°C.
- Sistema Termostop Block de limitación de la temperatura máxima del agua caliente.

Ensayos

- Ensayos de estanquidad, caudal, comportamiento mecánico bajo presión, resistencia mecánica, dimensiones, acústica y corrosión, realizados según las exigencias de las Normas Europeas EN 817 y EN 248.

Composición y recambios

- Manecilla : 3600-35NM (36Z303038)
- Cobertor tuerca cartucho : 4980NM (AAZ303179)
- Tuerca cartucho : TSC351 (250863)
- Cartucho : 35100 (252204)
- Aireador : 1534NM (AAZ308050)
- Inversor : 3675MNM (AAZ304007)
- Valvula antiretorno : ARD15 (181680)
- Asiento : AGM-2INM (AAZ305697)
- Tuerca de asiento : T3/42CNM (AAZ304008)
- Floron + excéntrica : 1326NM (AAZ303195)
- Anillo limitador de temperatura: ALT350 (300062)



Observaciones



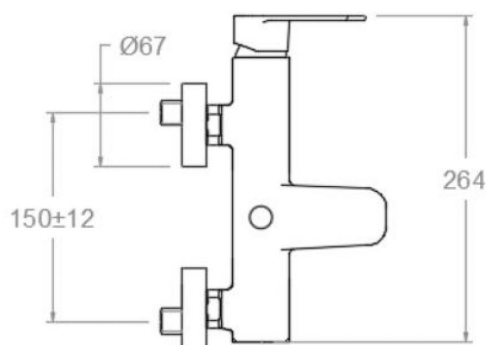
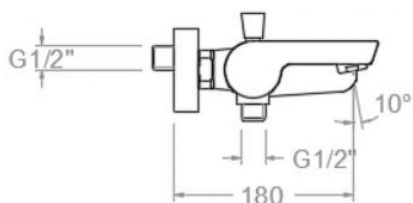

Alexia matt black, bath and shower mixer 360501SNM

Collection: Alexia	Finish: Black matte	Code: 36C303662
Location: Bath	Category: Bathtub	Certification: N II D/A

Technical characteristics

- Certification AENOR.
- Ceramic cartridge Ø35 mm.
- Water saving system S2 through the handle opening in two fases.
- Flow rate at 3 bar: 20 l/min through bath outlet and 12 l/min through shower outlet.
- Thermal shock resistant and anti-Legionella chemical.
- Guarantee of 5 year for tapware and 3 years for accesories.
- Use pressure between 1-5 bar. Recomend pressure 3 bar.
- Resists static pressure equal to or less than 10 bar and water hammer up to 25 bar.
- 3 bar acoustic level less than 20 dB.
- Comfort benefits of fidelity, sensibility and constancy in temperature selection.
- Recomend temperature for hot water: 55°C. Maximum temperature of use: 65°C up to 1 hour at 90°C.
- Termostop Black system for maximum water temperature limitation.

Tests

- Water tightness, flow rate, mechanical behavior under pressure, mechanical resistance, dimensional, acoustical and corrosion test according to european standards EN 817 and EN 248.

Composition and spare parts

• Handle:	3600-35NM (36Z303038)
• Cartridge nut cover:	4980NM (AAZ303179)
• Cartridge nut:	TSC351 (250863)
• Cartidge:	35100 (252204)
• Aerator:	1534NM (AAZ308050)
• Diverter valve:	3675MNM (AAZ304007)
• Check valve:	ARD15 (181680)
• Seat:	AGM-2INM (AAZ305697)
• Screw seat:	T3/42CNM (AAZ304008)
• Escutcheon + Eccentric:	1326NM (AAZ303195)
• Temperature limiter ring:	ALT350 (300062)

Observations





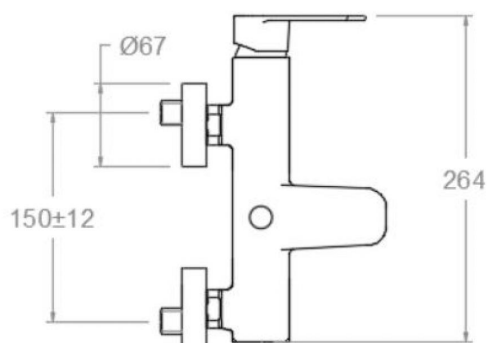
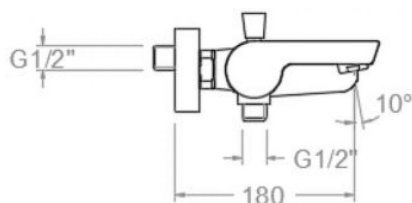

Alexia noir mat, monocommande de bain-douche 360501SNM

Collection:	Fini:	Code:
Alexia	Noir mat	36C303662
Lieu:	Catégorie:	Certification:
Bain	Baignoire	N II D/A

Caractéristiques techniques

- Certification AENOR
- Cartouche céramique Ø35 mm.
- Système d'économie d'eau S2 à travers de l'ouverture de la manette en deux phases.
- Débit à 3 bar: 20 l/min en sortie bain et 12 l/min en sortie douche.
- Résistant au choc thermique et chimique anti-légionelle.
- Garantie de 5 ans en robinetterie et 3 ans en compléments.
- Pression d'utilisation entre 1-5 bar. Recommandée à 3 bar.
- Résiste pressions statiques égal ou inférieur à 10 bar et coups de bélier de 25 bar.
- Niveau acoustique à 3 bar: inférieur à 20 dB.
- Prestations de confort au niveau de fidélité, sensibilité et contance dans la sélection de la température.
- Température recommandée d'eau chaude 55°C. température maximum d'utilisation 65°C. maximum 1h à 90°C.
- Système Termostop Block de limitation de la température maximum d'eau chaude.

Essais

- Essais d'étanchéité, débit, comportement mécanique sous pression, résistance mécanique, dimensions, acoustique et corrosion, fait selon les exigences des Normes Européenne EN 817 et EN 248.

Composition et pièces de rechange

- Manette: 3600-35NM (36Z303038)
- Écrou de fixation cartouche: 4980NM (AAZ303179)
- Écrou de cartouche: TSC351 (250863)
- Cartouche: 35100 (252204)
- Aérateur: 1534NM (AAZ308050)
- Inverseur: 3675MNM (AAZ304007)
- Clapet anti-retour: ARD15 (181680)
- Siège: AGM-2INM (AAZ305697)
- Écrou siège: T3/42CNM (AAZ304008)
- Rosace + Excentrique: 1326NM (AAZ303195)
- Bague limiteur de température: ALT350 (300062)



Observations



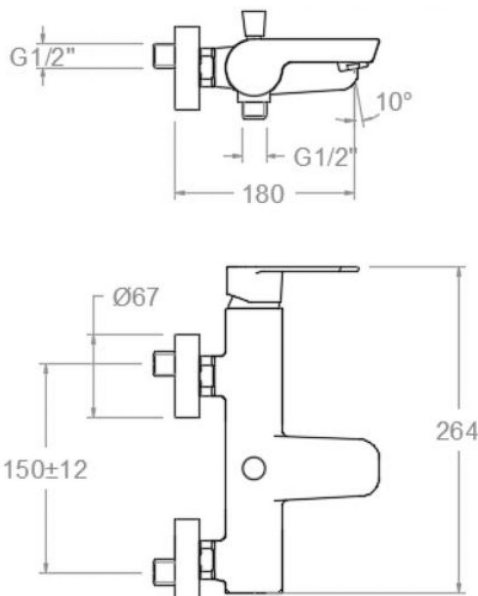

ALEXIA Einhebel-Wannenfüll- und Brausebatterie schwarz matt 360501SNM

Sammlung: Alexia	Ausführung: Matte schwarz	Code: 36C303662
Standort: Wannenfüll	Kategorie: Wannenfüll	Zertifizierung: N II D/A

Technische eigenschaften

- AENOR Zertifizierung.
- Keramik-Kartusche Ø35mm.
- Wassereinsparung S2, Öffnung über einen Zwischenanschlag.
- Durchfluss bei 3 bar: 20 l/min Ausgang Wanne und 12 l/min Ausgang Dusche.
- Widerstandsfähigkeit bei Anti-Legionellen Temperaturschock.
- 5 Jahre Garantie auf Armaturen bei Herstellungsfehler und 3 Jahre auf Zubehör und Komponenten.
- Optimales Durchflussvolumen bei 3 bar. Wasserdruck zwischen 1 bis 5 bar.
- Druckdicht bei gleich oder unter 10 bar und Druckschläge bei 25 bar.
- Geräuschkategorie I. Geräuschpegel bei 3 bar: unter 20 dB.
- Komfortleistungen von Sicherheit, Sensibilität und Konstanz bei der Temperatursauswahl.
- Heißwassertemperatur-Empfehlung von 55°C. Maximale Temperatur 65°C. Maximal 1 Stunde bei 90°C.
- Thermostop Block-System zur Begrenzung der maximalen Warmwassertemperatur.

Qualitätsprüfung

- Dichtheits-, Durchfluss-, mechanisches Verhalten unter Druck, mechanische Widerstands-, Maß-, Geräusch- und Korrosionsprüfung, gemäß den europäischen Normen EN 817 und EN 248.

Ersatzteile-aufstellung

- Hebel: 3600-35NM (36Z303038)
- Kartuschenringblende: 4980NM (AAZ303179)
- Kartuschenmutter: TSC351 (250863)
- Kartusche: 35100 (252204)
- Luftsprudler : 1534NM (AAZ308050)
- Umsteller: 3675MNM (AAZ304007)
- Rückflussverhinderungsventil : ARD15 (181680)
- Befestigungssitz: AGM-2INM (AAZ305697)
- Mutter für Befestigungssitz: T3/42CNM (AAZ304008)
- S-Anschluss + Zierblende: 1326NM (AAZ303195)
- Temperaturbegrenzungsring: ALT350 (300062)



Bemerkungen



ramonsoler.

→ rsramonsoler.com